

TECHNICAL SHEET | SCHEDA TECNICA

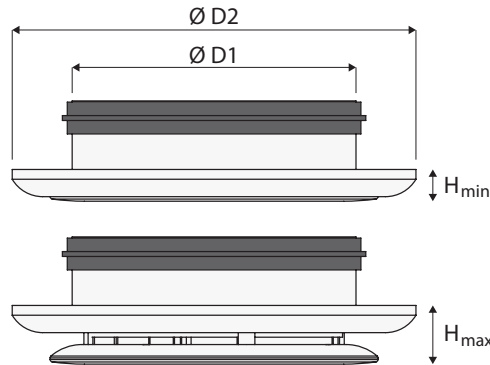

Cod.
7045155

Ø D1	Ø D2	Hmin	Hmax
[mm]			
119	165	12	24

DESCRIPTION

Duct terminal for the supply or exhaust of room air, made of plastic material (equivalent to RAL 9010), consisting of a central rotating shutter and adjustable grille for air flow calibration. It is suitable for ceiling or wall installation, compatible with DN 125 mm pipes, and for limited flow rates. External dimensions: Ø 165x12 mm. Single pack.

DESCRIZIONE

Griglia di mandata e ripresa dell'aria in materiale plastico bianco (equivalente a RAL 9010), costituita da un otturatore centrale ruotabile e griglia regolabile per la taratura del lancio. Può essere installata a soffitto o parete, compatibile con tubazioni DN 125 mm, ed è adatta a portate limitate. Dimensione esterne Ø 165x12 mm. Confezione singola.

REMOVAL DEFLECTORS

Thanks to the deflectors (removable) it is possible to orientate, in particular applications, the flow of air intake in the desired direction.

DEFLETTORI REMOVIBILI

Grazie ai deflettori (removibili) è possibile orientare, in applicazioni particolari, il flusso di immissione aria nella direzione desiderata.

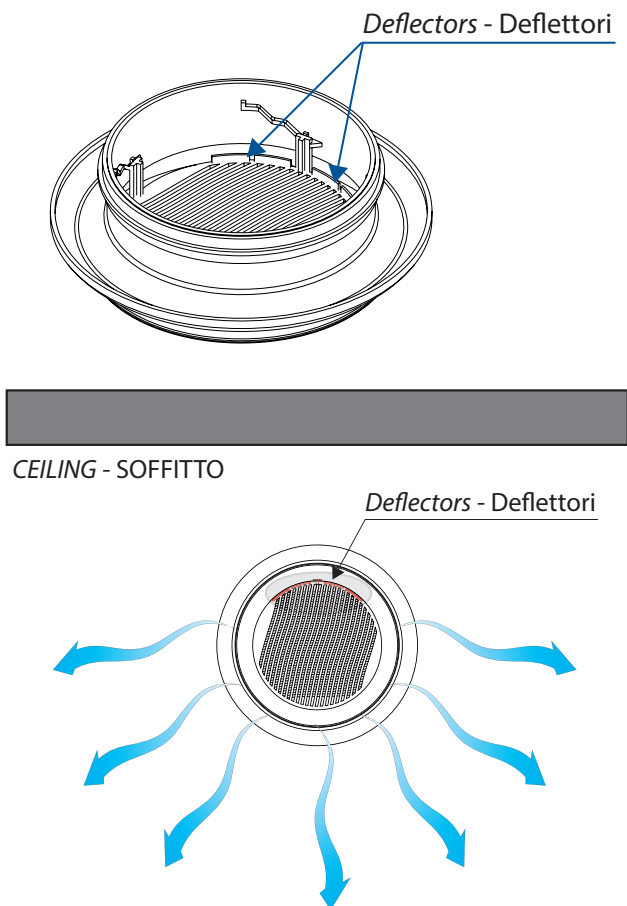

APPLICATION EXAMPLE - ESEMPIO DI APPLICAZIONE

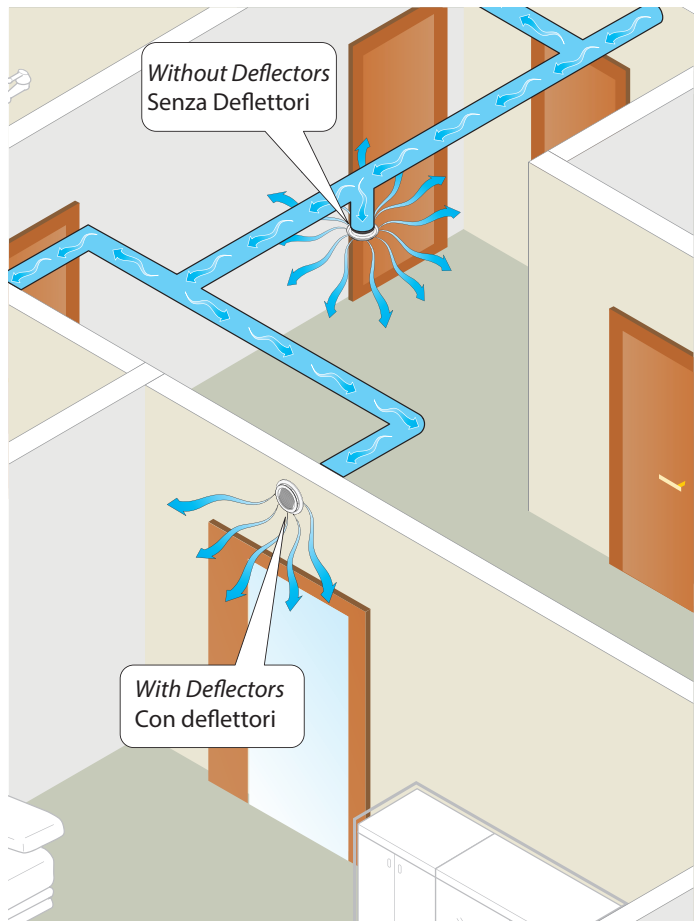

TECHNICAL SHEET | SCHEDA TECNICA



Grill opening/closing
Apertura/Chiusura Griglia

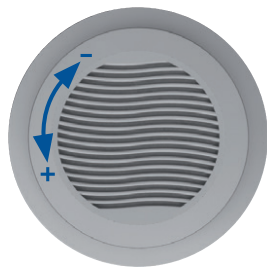

Shutter Opening/Closing
Apertura/Chiusura Otturatore

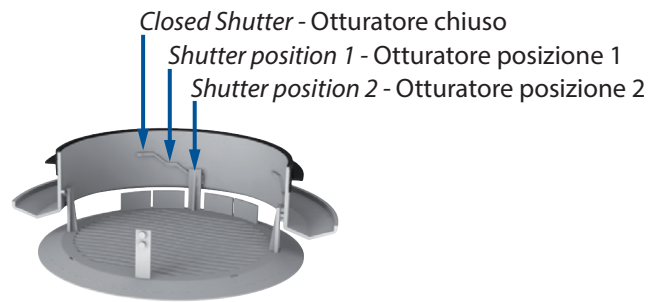

Closed Shutter - Otturatore chiuso
Shutter position 1 - Otturatore posizione 1
Shutter position 2 - Otturatore posizione 2

ROOM AIR SUPPLY - MANDATA ARIA IN AMBIENTE



Open grid - Griglia aperta

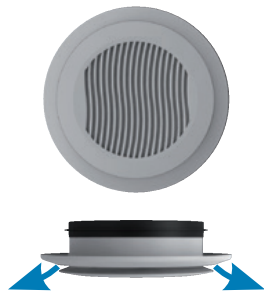

Closed grid - Griglia chiusa

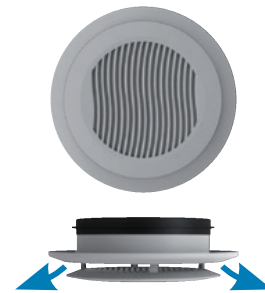

Shutter position 2 with/without deflectors
Otturatore posizione 2 con/senza deflettori

Closed shutter
Otturatore chiuso

Shutter position 1 without deflectors
Otturatore posizione 1 senza deflettori

EXTRACT ROOM AIR - RIPRESA ARIA AMBIENTE

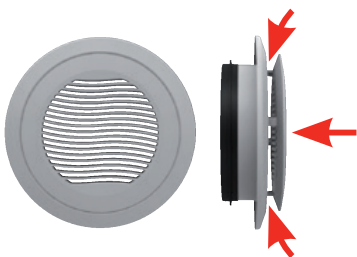

Open grid - Griglia aperta

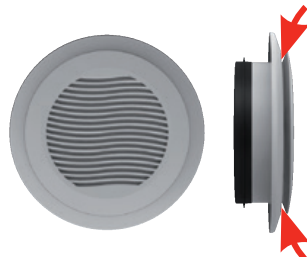

Closed grid - Griglia chiusa

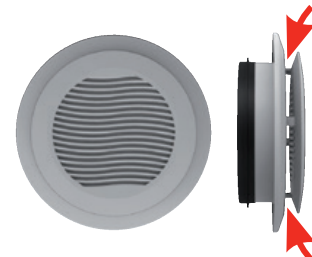

Shutter position 2 without deflectors
Otturatore posizione 2 senza deflettori

Shutter position 2
Otturatore posizione 2

Shutter position 1 without deflectors
Otturatore posizione 1 senza deflettori

	SUPPLY - MANDATA								EXTRACT - RIPRESA					
Deflectors - Deflettori	-		No-No				Yes-Si		-					
Grid - Griglia	Open-Aperta		Close-Chiusa						Open-Aperta		Close-Chiusa			
Shutter - Otturatore	Close-Chiuso		Open-Aperto						Open-Aperto					
Position - Posizione	-		1		2		2		2		1		2	
Air Flow rate Portata Aria	DP (Pa)	Lw dB(A)	DP (Pa)	Lw dB(A)	DP (Pa)	Lw dB(A)	DP (Pa)	Lw dB(A)	DP (Pa)	Lw dB(A)	DP (Pa)	Lw dB(A)	DP (Pa)	Lw dB(A)
45 m ³ /h	9	<20	18	<20	7	<20	13	22	3	<20	20	23	7	<20
60 m ³ /h	17	<20	30	26	13	21	20	27	5	<20	37	33	13	21
75 m ³ /h	25	24	40	35	18	24	31	32	8	<20	57	41	20	25
90 m ³ /h	36	34	56	39	25	28	43	36	11	20	80	46	27	29
120 m ³ /h	62	43	-	-	40	36	70	43	19	28	-	-	48	36
150 m ³ /h	-	-	-	-	62	41	-	-	28	34	-	-	74	43

